

18" Aerocowl

Installation Instructions

Depending on individual applications, not all hardware may be used.

The UNIVERSAL BASE hardware package should include:

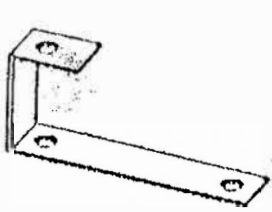

4-J BARS

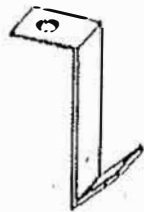

4-SPRING CLIPS



4-FLAT BARS



4-NUTS



4-BOLTS

Make sure chimney flue is properly cleaned before installing your Aerocowl.

Choose the correct clamping device configuration, based on the size of your flue, and attach clamping hardware as shown in diagrams below.

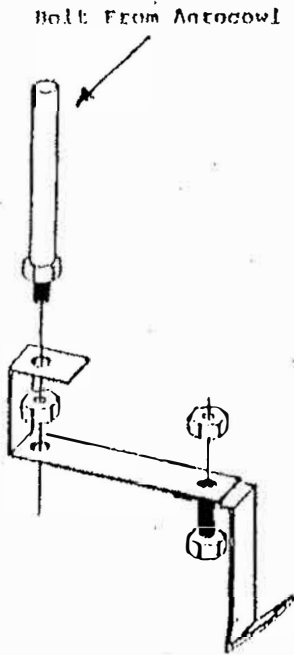

12" x 12" Square Tile

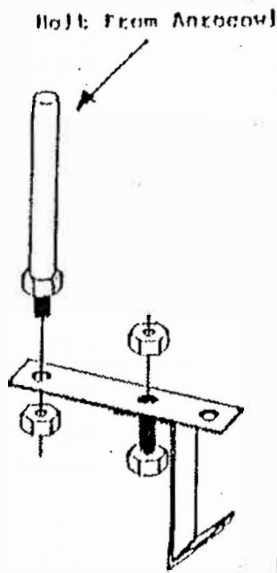

12" Round Flue

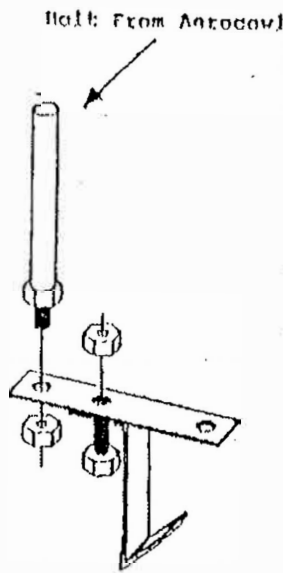

10" Round Flue

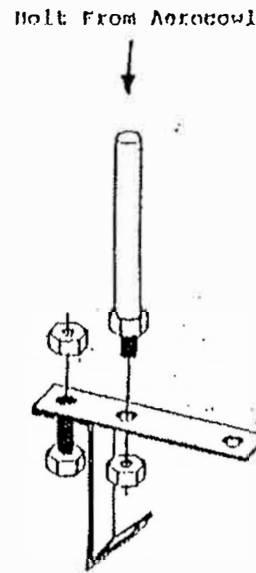

7" Round Flue
8" x 12" Rectangular Tile
8" x 8" Square Tile

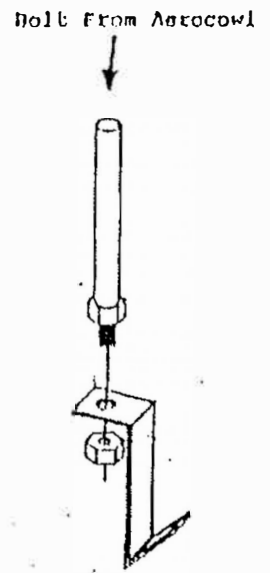

10" x 12" Rectangular Tile
10" x 10" Square Tile

Bracket Mounting Location

ROUND FLUE CONFIGURATION

SQUARE & RECTANGULAR TILE CONFIGURATION

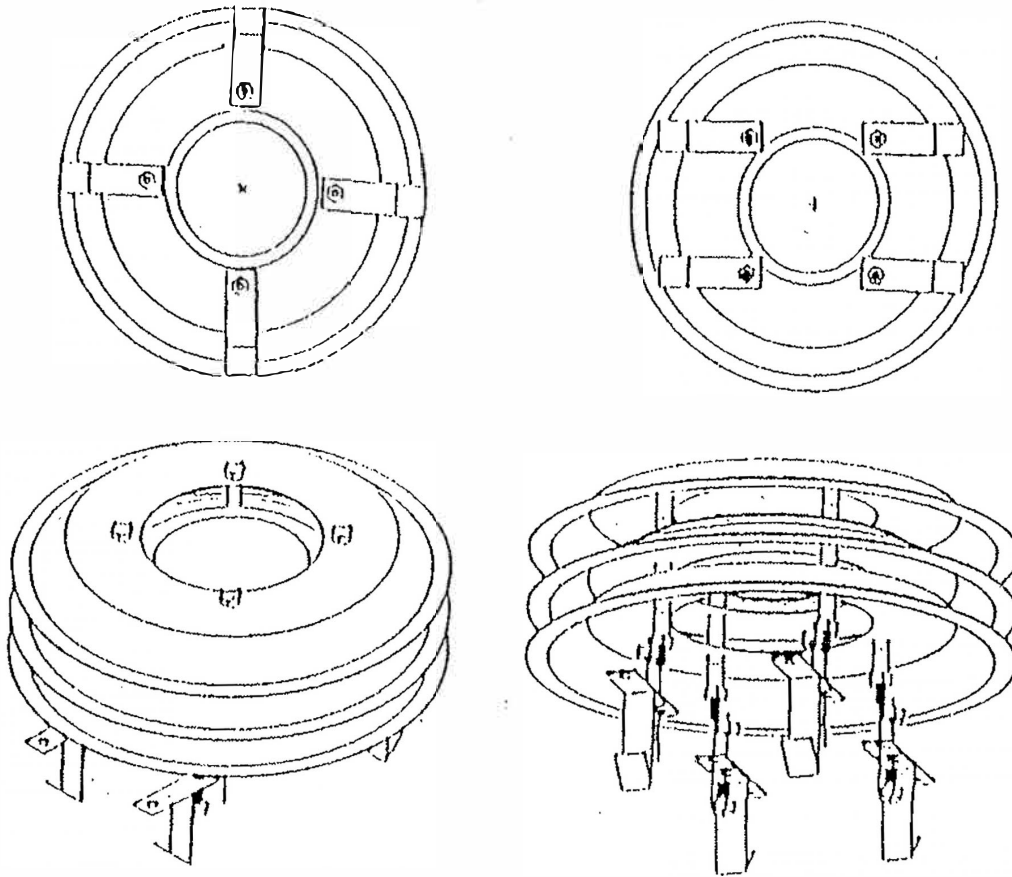

IMPORTANT NOTE: DUE TO SLIGHT VARIATION IN FLUE SIZES IT MAY BE NECESSARY TO BEND THE SPRING CLIPS TO ENSURE PROPER FIT.

After brackets are located correctly, tighten all nuts securely.

Position the AEROCOWL over the center of the flue opening. Apply even pressure to the top of the AEROCOWL with both hands (with gloves) and push downward until the support arms of the clamping device are resting on the edge of the flue tile.

(see diagram below)

